



■ Features

- Constant Voltage PWM style output with frequency 1.47kHz
- Plastic housing with class II design
- Built-in active PFC function
- Class 2 power unit(except PWM-90-12)
- No load power consumption <0.5W
- Fully encapsulated with IP67 level
- Function: 3 in 1 dimming (dim-to-off); DALI
- Typical lifetime>50000 hours
- 5 years warranty

■ Applications

- LED strip lighting
- Indoor LED lighting
- LED decorative lighting
- LED architecture lighting

■ Description

PWM-90 series is a 90W LED AC/DC LED driver featuring the constant voltage mode with PWM style output, which is able to maintain the color temperature and the brightness homogeneity when driving all kinds of LED strips. PWM-90 operates from 90~305VAC and offers models with different rated voltage ranging between 12V and 48V. Thanks to the high efficiency up to 90.5%, with the fanless design, the entire series is able to operate for -40°C ~ +85°C case temperature under free air convection. The entire series is rated with IP67 ingress protection level and is suitable to work for dry, damp or wet locations. PWM-90 is equipped with dimming function that varies the duty cycle of the output, providing great flexibility for LED strips applications.

■ Model Encoding

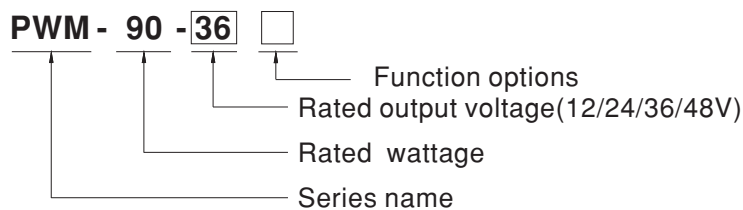

| Type | IP Level | Function | Note |
|-------|----------|--|------------|
| Blank | IP67 | 3 in 1 dimming function (0~10Vdc, 10V PWM signal and resistance) | In Stock |
| DA | IP67 | DALI control technology. | By request |



SPECIFICATION

| MODEL | PWM-90-12 | PWM-90-24 | PWM-90-36 | PWM-90-48 | |
|--------------|---|--|---------------|---------------|----------|
| OUTPUT | DC VOLTAGE | 12V | 24V | 36V | 48V |
| | RATED CURRENT | 7.5A | 3.75A | 2.5A | 1.88A |
| | RATED POWER | 90W | 90W | 90W | 90.24W |
| | DIMMING RANGE | 0 ~ 100% | | | |
| | PWM FREQUENCY (Typ.) | 1.47kHz | | | |
| | SETUP, RISE TIME Note.2 | 500ms, 80ms/ 115VAC or 230VAC | | | |
| | HOLD UP TIME (Typ.) | 16ms/115VAC or 230VAC | | | |
| INPUT | VOLTAGE RANGE Note.3 | 90 ~ 305VAC 127 ~ 431VDC (Please refer to "STATIC CHARACTERISTIC" section) | | | |
| | FREQUENCY RANGE | 47 ~ 63Hz | | | |
| | POWER FACTOR (Typ.) | PF>0.98/115VAC, PF>0.96/230VAC, PF>0.94/277VAC @ full load (Please refer to "POWER FACTOR (PF) CHARACTERISTIC" section) | | | |
| | TOTAL HARMONIC DISTORTION | THD< 20% (@load≥60%/115VAC, 230VAC; @load≥75%/277VAC) (Please refer to "TOTAL HARMONIC DISTORTION" section) | | | |
| | EFFICIENCY (Typ.) | 88% | 90.5% | 90.5% | 90.5% |
| | AC CURRENT (Typ.) | 0.95A / 115VAC | 0.5A / 230VAC | 0.4A / 277VAC | |
| | INRUSH CURRENT (Typ.) | COLD START 60A(twidth=550μs measured at 50% Ipeak) at 230VAC; Per NEMA 410 | | | |
| | MAX. NO. of PSUs on 16A CIRCUIT BREAKER | 3 units (circuit breaker of type B) / 6 units (circuit breaker of type C) at 230VAC | | | |
| | LEAKAGE CURRENT | <0.25mA / 277VAC | | | |
| | NO LOAD POWER CONSUMPTION | <0.5W | | | |
| PROTECTION | OVERLOAD | 108 ~ 120% rated output power Hiccup mode, recovers automatically after fault condition is removed | | | |
| | SHORT CIRCUIT | Shut down o/p voltage, re-power on to recover | | | |
| | OVER VOLTAGE | 15 ~ 17V | 28 ~ 34V | 41 ~ 46V | 54 ~ 60V |
| | | Shut down o/p voltage, re-power on to recover | | | |
| | OVER TEMPERATURE | Shut down o/p voltage, re-power on to recover | | | |
| ENVIRONMENT | WORKING TEMP. | Tcase=-40 ~ +85°C (Please refer to " OUTPUT LOAD vs TEMPERATURE" section) | | | |
| | MAX. CASE TEMP. | Tcase=+85°C | | | |
| | WORKING HUMIDITY | 20 ~ 95% RH non-condensing | | | |
| | STORAGE TEMP., HUMIDITY | -40 ~ +80°C, 10 ~ 95% RH | | | |
| | TEMP. COEFFICIENT | ±0.03%/°C (0 ~ 50°C) | | | |
| | VIBRATION | 10 ~ 500Hz, 5G 12min./1cycle, period for 72min. each along X, Y, Z axes | | | |
| SAFETY & EMC | SAFETY STANDARDS Note.5 | UL8750, CSA C22.2 No. 250.13-12; ENEC EN61347-1, EN61347-2-13 independent, EN62384, IP67 approved; Design refer to EN60335-1 | | | |
| | DALI STANDARDS | Comply with IEC62386-101, 102, 207 for DA-Type only | | | |
| | WITHSTAND VOLTAGE | I/P-O/P: 3.75KVAC | | | |
| | ISOLATION RESISTANCE | I/P-O/P: 100M Ohms / 500VDC / 25°C / 70% RH | | | |
| | EMC EMISSION Note.6 | Compliance to EN55015, EN61000-3-2 Class C (@load≥60%); EN61000-3-3 | | | |
| | EMC IMMUNITY | Compliance to EN61000-4-2, 3, 4, 5, 6, 8, 11; EN61547, light industry level (surge immunity Line-Line 2KV) | | | |
| OTHERS | MTBF | 902.4K hrs min. Telcordia SR-332 (Bellcore); 224.2K hrs min. MIL-HDBK-217F (25°C) | | | |
| | DIMENSION | 171*63*37.5mm (L*W*H) | | | |
| | PACKING | 0.77Kg; 18pcs/14.9Kg/0.97CUFT | | | |
| NOTE | <ol style="list-style-type: none"> All parameters NOT specially mentioned are measured at 230VAC input, rated current and 25°C of ambient temperature. De-rating may be needed under low input voltages. Please refer to "STATIC CHARACTERISTIC" sections for details. Length of set up time is measured at first cold start. Turning ON/OFF the driver may lead to increase of the set up time. The driver is considered as a component that will be operated in combination with final equipment. Since EMC performance will be affected by the complete installation, the final equipment manufacturers must re-qualify EMC Directive on the complete installation again. The model certified for CCC(GB19510.14, GB19510.1, GB17743 and GB17625.1) is an optional model. Please contact MEAN WELL for details. This series meets the typical life expectancy of >50,000 hours of operation when Tcase, particularly (tc) point (or TMP, per DLC), is about 75°C or less. Please refer to the warranty statement on MEAN WELL's website at http://www.meanwell.com | | | | |

DIMMING OPERATION

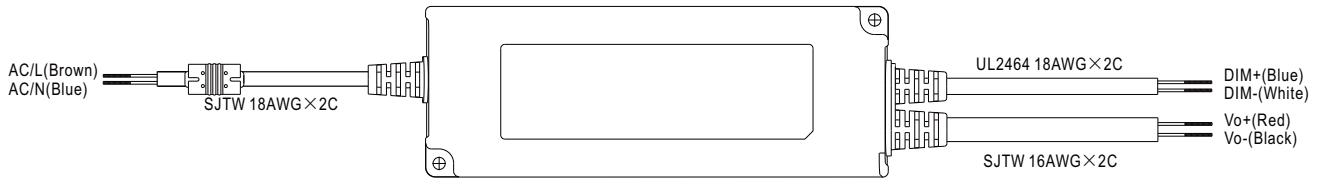

※ **Dimming principle for PWM style output**

- Dimming is achieved by varying the duty cycle of the output current.

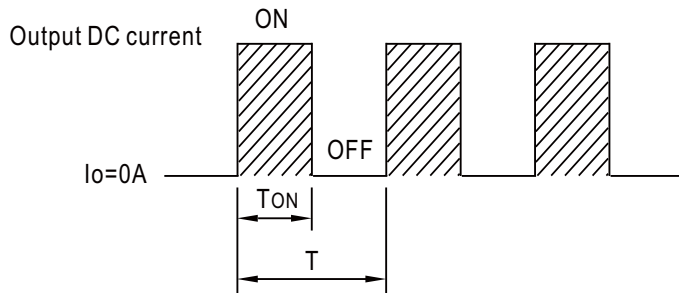

$$\text{Duty cycle(\%)} = \frac{T_{ON}}{T} \times 100\%$$

Output PWM frequency : 1.47kHz fixed (Typ.)

※ **3 in 1 dimming function (for Blank-Type)**

- Apply one of the three methodologies between DIM+ and DIM-: 0 ~ 10VDC, or 10V PWM signal or resistance.
- Dimming source current from power supply: 100μA (typ.)

◎ Applying additive 0 ~ 10VDC

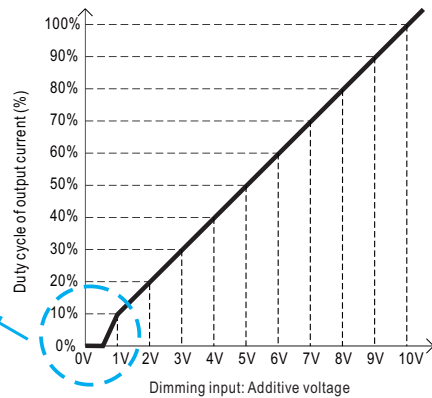
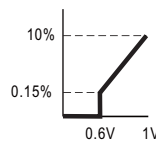
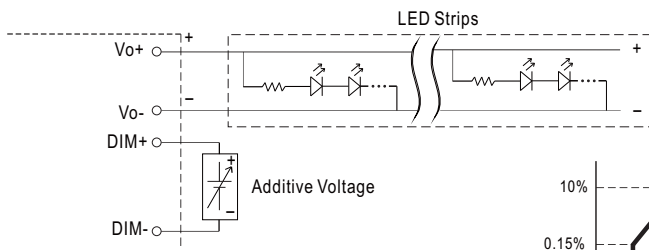

◎ Applying additive 10V PWM signal (frequency range 100Hz ~ 3KHz):

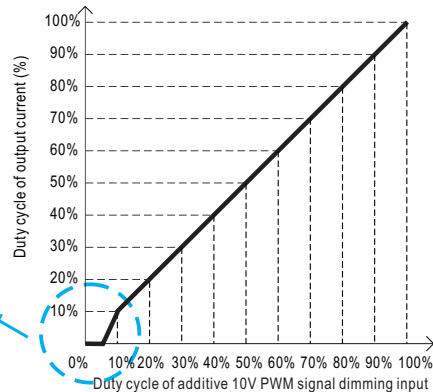
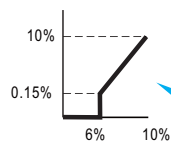
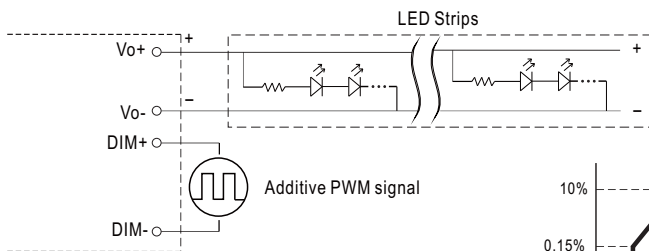

© Applying additive resistance:

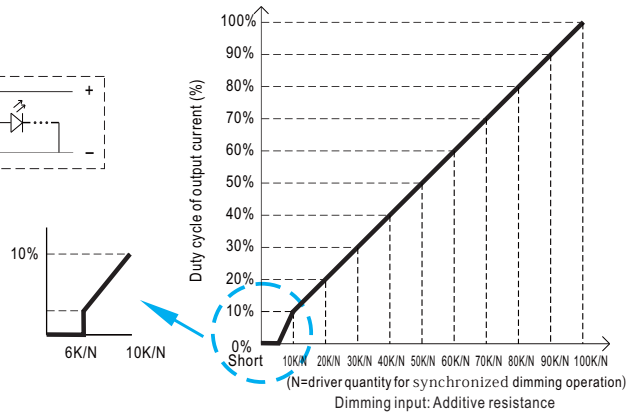
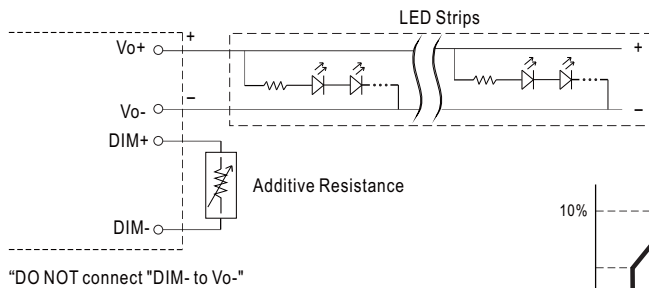

- Note :
1. Min. duty cycle of output current is about 0.15%, and the dimming input is about $6K\Omega$ or 0.6VDC, or 10V PWM signal with 6% duty cycle.
 2. The duty cycle of output current could drop down to 0% when dimming input is less than $6K\Omega$ or less than 0.6VDC, or 10V PWM signal with duty cycle less than 6%.

※ DALI Interface (primary side; for DA-Type)

- Apply DALI signal between DA+ and DA-.
- DALI protocol comprises 16 groups and 64 addresses.
- First step is fixed at 6% of output

OUTPUT LOAD vs TEMPERATURE

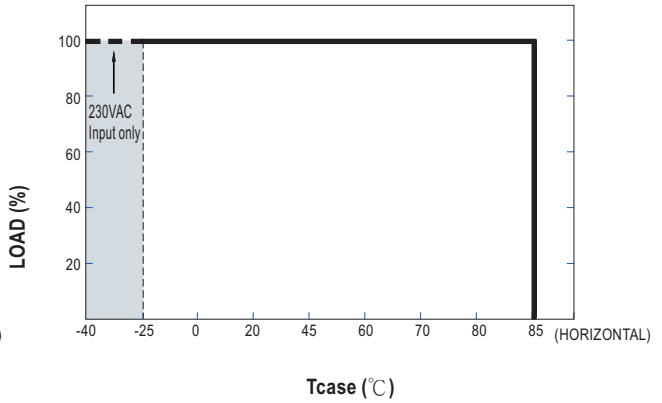
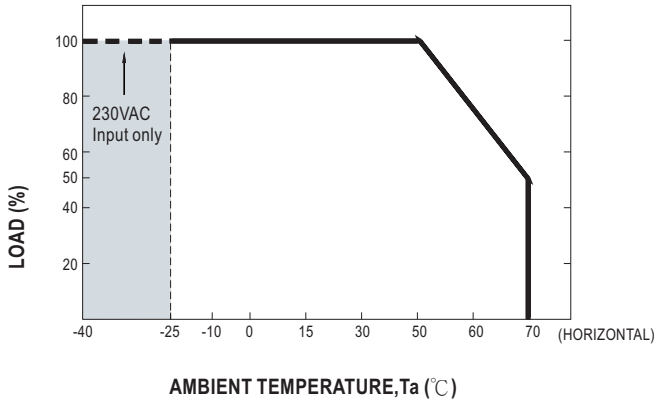

STATIC CHARACTERISTIC

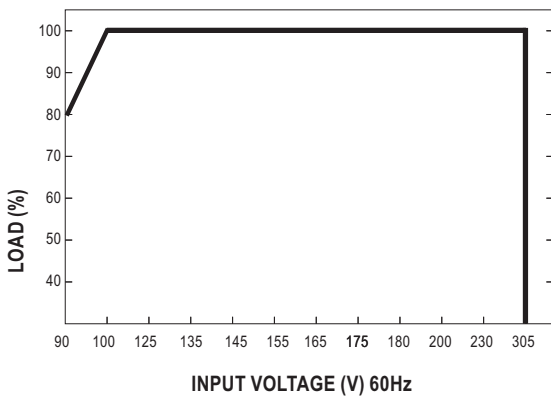

※ De-rating is needed under low input voltage.

POWER FACTOR (PF) CHARACTERISTIC

※ Tcase at 75°C

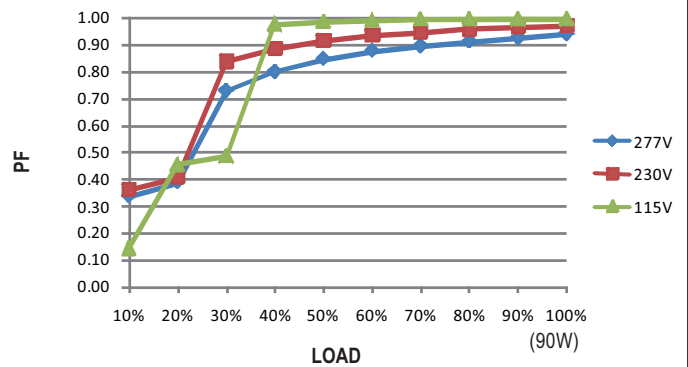

TOTAL HARMONIC DISTORTION (THD)

※ 48V Model, Tcase at 75°C

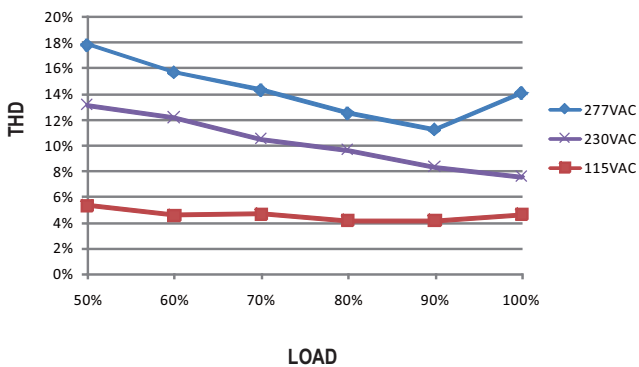

EFFICIENCY vs LOAD

PWM-90 series possess superior working efficiency that up to 90.5% can be reached in field applications.

※ 48V Model, Tcase at 75°C

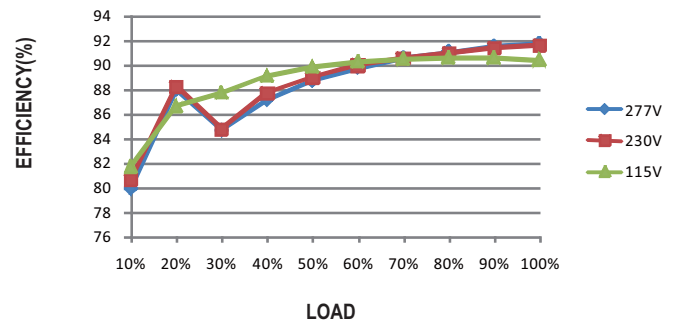

■ LIFE TIME

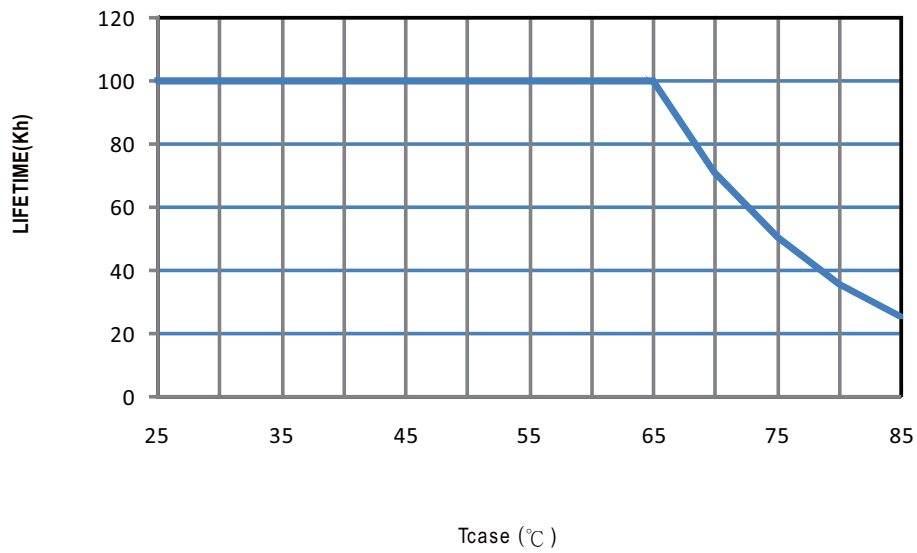

Block Diagram

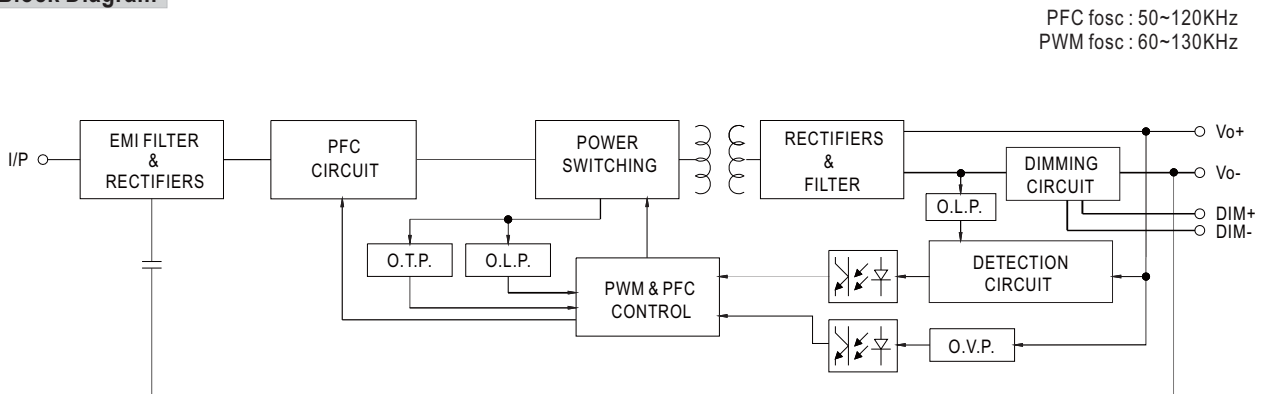

Mechanical Specification

Case No. PWM-90P Unit:mm

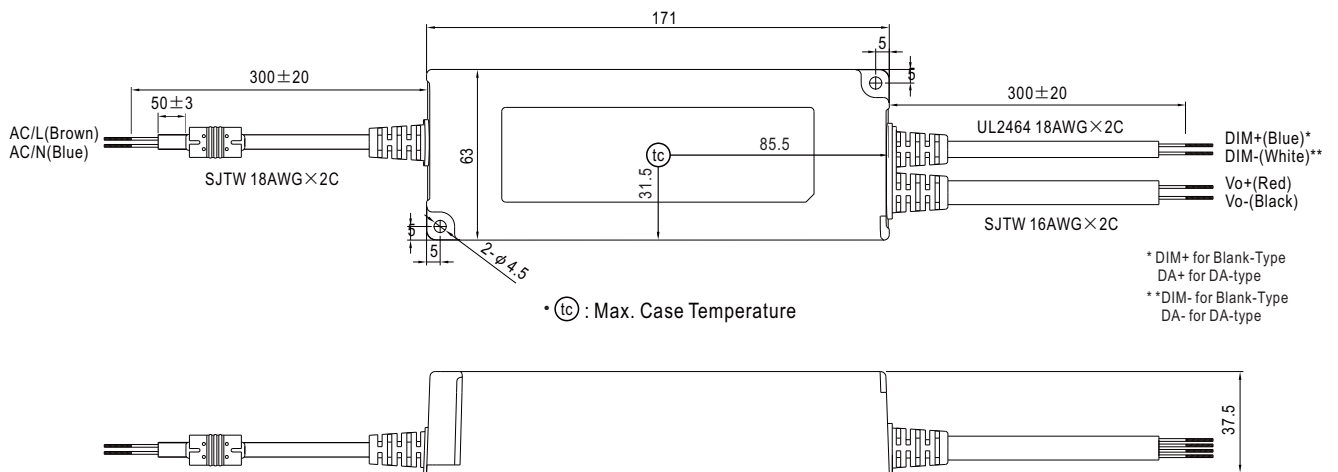

■ Installation Manual

◎ Connection for Blank-type

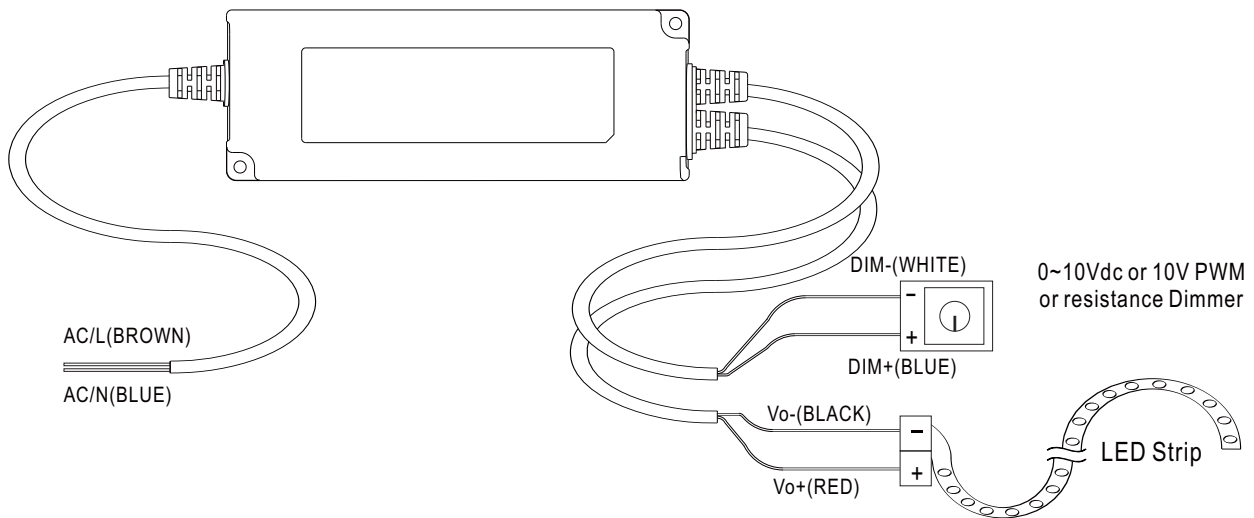

◎ Cautions

- Before commencing any installation or maintenance work, please disconnect the power supply from the utility. Ensure that it cannot be re-connected inadvertently!
- Keep proper ventilation around the unit and do not stack any object on it. Also a 10-15 cm clearance must be kept when the adjacent device is a heat source.
- Mounting orientations other than standard orientation or operate under high ambient temperature may increase the internal component temperature and will require a de-rating in output current.
- Current rating of an approved primary /secondary cable should be greater than or equal to that of the unit. Please refer to its specification.
- For LED drivers with waterproof connectors, verify that the linkage between the unit and the lighting fixture is tight so that water cannot intrude into the system.
- For dimmable LED drivers, make sure that your dimming controller is capable of driving these units. PWM series require 0.15mA each unit.
- Tc max. is identified on the product label. Please make sure that temperature of Tc point will not exceed limit.
- DO NOT connect "DIM- to Vo-".
- Suitable for indoor use or outdoor use without direct sunlight exposure. Please avoid immerse in the water over 30 minutes.
- The power supply is considered as a component that will be operated in combination with final equipment. Since EMC performance will be affected by the complete installation, the final equipment manufacturers must re-qualify EMC Directive on the complete installation again.
- For more information about installation, please refer to www.meanwell.com/webnet/search/installationsearch.html for details.